

Commentary

Uranus, I

- (2:00 P.M.) P.M. must be included.
 - (7:30 A.M.) A.M. must be included. The time of flight as well as the time differential between time zones is considered in solving the problem.
- (50 minutes) Drawing a picture helps in solving this problem. Students then see that only 2 cuts are needed to cut the log into 3 pieces, so it takes 10 minutes to saw through the log. It always takes one less cut than the number of pieces needed. To get 6 pieces you will make 5 cuts at 10 minutes each.
- (5, 17, 23) *Guess, check, and revise* is a suggested strategy. Students should recognize that the number is divisible by 5 since 1955 ends in 5. $5 \times 391 = 1955$. They can then choose prime factors to multiply that might equal 391.
- ($99\frac{9}{9}$; or $99 + (9 \div 9)$; other answers possible) Students will probably realize that they can put two nines together to get 99, which is 1 away from the goal of 100. Therefore they need to find a way to put the other two nines together, to get 1. $9 \div 9$ works.
- (The triangles can be turned to suggest other solutions.)

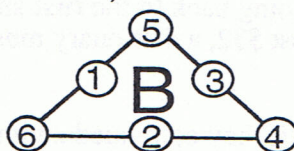
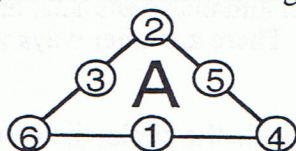

- (8 minutes) Drawing a diagram helps students see that the train will have to travel 2 miles from where the engine is just entering the tunnel to where its caboose is out of the tunnel. 15 mph means the train is going $\frac{1}{4}$ mile per minute. So it would take 8 minutes to travel 2 miles.

This problem may also be solved with a proportion:

$$\frac{2}{x} = \frac{15}{60}$$

- (a. 6; b. 14) It is helpful to draw in the lines connecting the dots and count the squares and half-squares for part a. For part b, draw in rectangles whose diagonals are the sides of the figure on the left end -- the area of the end triangles is then half of the surrounding rectangle.

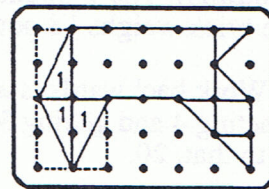

- (15) This problem is a concrete example related to algebraic thinking. Students intuitively know that they can find the weight of 2 ducks by taking the known weights off the scale, and the display will show $61 - 31$, or 30. So they divide that result by 2 to obtain the weight of one duck. These steps give concrete meaning to solving this sort of linear equation.

Commentary

Uranus, II

1. Mark out any two of the 4 corners and you will leave 7 squares. Two such cases are shown:

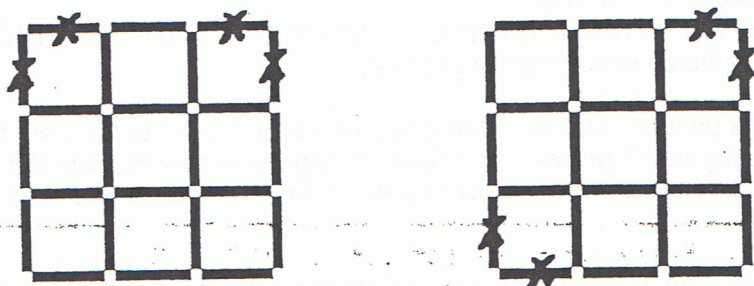

2. (3 socks) If the first two socks he draws are a brown and a blue, the next sock drawn has to match one of those.
3. (dictionary: \$10; almanac: \$22) The problem involves the same sort of thinking that students can later use to solve a system of equations in two unknowns, in algebra. In this case, students might reason that since a dictionary and almanac together cost \$32, then twice that amount would cost twice as much -- i.e., 2 dictionaries and 2 almanacs would cost \$64. But we know 2 dictionaries and 3 almanacs cost \$86, so the difference of 1 almanac must be \$86 - \$64 or \$22. Then going back to the first situation, if an almanac costs \$22, and a dictionary and almanac cost \$32, a dictionary must cost \$10. There are other ways to arrive at this same conclusion.
4. (4) Students can see that, if they continued adding squares inside the circle, the inner figure would approach becoming a circle itself. This is well known in string designs.
5. (2 years, 292 days, 20 hours, 44 minutes, 53 seconds) Students will need to "borrow" in this problem, differently from what they have done in base-ten work. The time on the top line can be rewritten as 4 years, 385 days, 27 hours, 91 minutes, 77 seconds so that the bottom number can be subtracted, one term at a time.
6. (27 pounds) The 9-pound weight must be the same weight as 1/2 brick, so we know that a whole brick weighs 18 pounds. Therefore a brick and a half weighs 18 + 9 or 27 pounds.
7. (20) Work backwards is a possible approach. The number must have been 43 prior to subtracting 4 and getting 39. Prior to the next step, it must have been 86; prior to that, 80, and prior to that, 20.
8. (12) If 4/7 of the students are girls, then 3/7 are boys. 1/7 of 28 is 4, so 3/7 of 28 is 12.
9. (a. 1/6 ; b. 2/6 or 1/3 ; c. 0 ; d. 3/6 or 1/2) For (a), since zero is one of six sections of the circle, the chances are 1/6. For (b), the odd numbers are 5 and 9 and represent 2 of the 6 sections, so the chance is 2/6 or 1/3. For (c), there is no section labeled with a number larger than 9, so there is no chance the spinner will give this result. For (d), there are two sections with odd numbers and one section labels with 0, giving three sections of the six, so the chances are 3/6 or 1/2.

Commentary

Uranus, III

1. (**less than 50**) 283 is less than 300, and 300 miles is how far they would have gone in six hours at 50 miles per hour.
2. (**32%**) The skirt cost \$36 and the blouse cost \$32 for a total of \$68. The original cost was \$100. The discount was 32%. Another way to think of the problem is to look at the total saved -- \$24 for the skirt and \$8 for the blouse. Therefore \$32 was saved, out of the original price of \$100.
3. (**531**) Students might organize their work by sectioning off parts and counting each part, and total the parts. Some students might make a long "chain" and count; others will count the dots in groups of 25 or 50.
4. (**7**) One approach is simply to *guess-check-revise* until you find a number that works for n . Another is to solve an equation such as $3n + 6 = n + 20$.
5. (**127°**) $78 - (-49) = 127$. Students might want to make a sketch of a number line, to convince them that the absolute values of the numbers must be added, to find the difference.
6. (**8**) Since the mean age is 11, the total of their three ages is 33. Since the middle child is 10 (the median), the sum of the remaining ages is 23. Rosa is 15, so the age of the youngest is $23 - 15 = 8$.
7. (**c = 21, d = 48, total = 69**) Figure C has three triangles -- MNO, MPL, and OMP. It also has 3 quadrilaterals -- OPLN, OPMN, and OPLM. This totals $9 + 12$ or 21 points. Figure D has two triangles (let O be the center point) -- VOW and SOR. It has 6 quadrilaterals -- TSOV, TSWV, XROW, XRSW, XRVW, TSRV. It also has 3 hexagons -- T \overline{S} R \overline{X} WV, TSROWV, and XRSOVW. This totals $6 + 24 + 18$ or 48 points. The grand total is then $21 + 48$ or 69 points. Note -- there are also 2 seven-sided figures. Some students might extend the scoring system, awarding 7 points for these two also, giving a total of 62 for figure D, and a grand total of 83.
8. (**19**) Students can substitute 4 in for a , and compute $3 + 4 + 7 - 5 + 10 + 4 - 4 = 19$.
9. (**3 & 5; 5 & 7; 11 & 13; 17 & 19; 29 & 31; 41 & 43**) Students might be encouraged to use a calculator to check and see if certain numbers are primes or not.

Commentary

Uranus, IV

- (14) The clock shows 3:00 twice daily. So in 7 days it would show $2 \times 7 = 14$.
- The seven discs in the center stay where they are.
The 3 corner discs move so that 2 are on the top and the other becomes the bottom of the triangle.

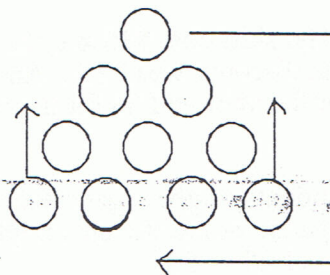

- (2 tables, 8 stools OR 5 tables, 4 stools) *Guess, check and revise* is a possible strategy along with a table to help organize information. Students can begin to guess a number for either the tables or stools, and see if, using that number of legs required, it's possible to make some of the other piece of furniture, using up all the legs.
- (6 in²) $48 \text{ in}^2 \div 8 \text{ faces} = 6 \text{ in}^2$. Some students might need help remembering that an octahedron has eight faces, or they might look it up in a dictionary.
- (4082) Since the clues all mention the thousands digit, start guessing what that number might be. It has to be an even number because the ones digit is half of it. It can't be more than 4 because the tens digit is twice that number, and twice an even number more than four would be a 2-digit number. Therefore the first guess might be either 2 or 4.
- (300 km) $1,000,000 \times 30 \text{ cm} = 30,000,000 \text{ cm}$, and dividing by 100 gives 300,000 meters. Dividing again by 1000 gives 300 km.
- (Amy Jackson–3rd; Betty Keller–1st; David Perez–4th; Ed Gonzales–2nd) Students might begin by making a chart like the one below, and proceed by eliminating possibilities. From the first clue, David and Ed can't be Jackson. The chart shows these last names eliminated from consideration beside their names. One proceeds in this fashion until the process of elimination shows who has which last name, and where they finish.

FIRST NAME	LAST NAME	POSITION
AMY	G J K P	1 2 3 4
BETTY	G J K P	1 2 3 4
DAVID	G X K P	1 2 3 4
ED	G X K P	1 2 3 4

- (74,999) This is the greatest number that can be rounded to 70,000.
- The pens are placed together to give another triangle shape in the center:



Commentary

Uranus, V

- | | |
|---|---|
| 1. $\begin{array}{r} 96233 \\ + 62513 \\ \hline 158746 \end{array}$ | Students might begin this problem by noting that $D = 1$, and that there are 3 S's and 3 R's. They might make boxes for all the digits, and fill in the 1 for D and then begin to guess the numbers that S and R might be. Start with a small number for S, perhaps 2, and then $R = 4$, and proceed to guess the other digits. This doesn't work, so try $S = 3$ and $R = 6$. This can be forced to work. |
|---|---|
- (5) The train would pass the train that left Jacksonville at 8:00 at the Tallahassee station -- it would pass the 9:00 train $1/4$ of the way to Jacksonville. It would pass the train that leaves on the same hour at the half-way mark, and the train that leaves Jacksonville at 11:00 at the $3/4$ point. It would also pass the train that leaves Jacksonville at 12:00, at the Jacksonville station.
- (\$8.95) Three hamburgers cost \$2.85; a hot dog cost \$0.85; 4 orders of fries cost \$3.56; and 4 soft drinks cost \$3.16. This totals \$10.42. Multiplying by 1.06 to add the tax gives \$11.05 when rounded up. $\$20.00 - \$11.05 = \$8.95$.
- (62.5% or 63%) 24 out of 64 squares are covered, so $40/64$ are not covered. On a calculator, $40 \div 64$ gives 0.625. Students might also reason that $40/64 = 5/8$ in lowest terms, and $5/8 = 62.5\%$.
- (17) Skip sees the same trees both times. Since he's going in the opposite direction going home, the trees appear on the other side of the street.
- (C, B, A) Students might want to draw the design on a sheet of paper, and actually turn the paper to see if they are correct.
- (5.9×10^9) *Scientific Notation* means that the number is written with one digit to the left of the decimal point, and the corresponding power of ten is used as the multiplier.
- (a. 1963; b. 1957; c. Mantle) For (a), there is only one year in which the dots for the batting averages are the same, although the lines cross "between years" in several places. For (b), 1957 is the year in which both hit more than 0.333. For (c), Mantle's range is from 0.345 to 0.295 while Mays' range is from 0.365 to 0.275. Mantle's range of 50 points is less than Mays' range of 90 points.

Commentary

Uranus, VI

- (7/8) The difference can be found by subtracting $5 \frac{1}{4}$ from $6 \frac{1}{8}$, or by “counting up” from $5 \frac{1}{4}$ to $6 \frac{1}{8}$. To do the latter, it's $\frac{3}{4}$ of an inch from $5 \frac{1}{4}$ inches to 6 inches, and another $\frac{1}{8}$ to $6 \frac{1}{8}$ inches. So the sum of $\frac{3}{4}$ and $\frac{1}{8}$, which is $\frac{6}{8} + \frac{1}{8}$ or $\frac{7}{8}$, is the difference.
- $$\begin{array}{r} .25 \\ \times 3.7 \\ \hline 175 \\ 75 \\ \hline 0.925 \end{array}$$
- (34 in²) There are 9 faces “facing you,” and another 9 on the other side. There are 11 faces that make up the “stair steps” portion, and another 5 on the bottom. This totals 34.
- (650 hr) Multiplying 27 days times 24 hours/day gives 648 hours. Add on 8 hours for the final $\frac{1}{3}$ day, and you're at 656 hours. As a rounded number, this is closest to 650 hours.
- (0) Washington has 10 letters. The second and sixth Presidents were both named Adams; so $5 - 5 = 0$. $10 \times 0 = 0$.
- (4,328,000,000,000)
- (I) $(40 \div 10) + 16 - 19 = 1$; 1 is written as I in Roman numerals.
- (a. $\frac{3}{8}$; b. $\frac{3}{8}$; c. $\frac{1}{4}$; d. 0) The red portion is $\frac{1}{4}$ plus $\frac{1}{2}$ of $\frac{1}{4}$ or $\frac{1}{8}$, which is $\frac{2}{8} + \frac{1}{8}$ or $\frac{3}{8}$. Blue is the same area as red, although it's made up of two pieces. Gold and green together would be $\frac{1}{8} + \frac{1}{8}$, or $\frac{1}{4}$. Orange isn't pictured, so the chance of getting orange is 0.
- (18) There are two types of sandwiches, three types of side orders, and three types of drinks; therefore $2 \times 3 \times 3 = 18$ gives the number of choices. For students who need a concrete experience to solve this problem, they might try labeling each choice, and combining the labels. For example, let A and B be the sandwich types, C, D, and E the side orders, and F, G, and H the drinks. Then ACF, ACG, ACH, ADF, ADG, ADH, AEF, AEG, and AEH are the combinations with the first type sandwich. There is the same number for the second type of sandwich.
- (3) $100\% - 87.5\% = 12.5\%$ that did not pass, and $12.5\% \times 24 = 3$.

Commentary

Uranus, VII

1. **(14)** $\frac{1}{8}$ of 336 is 42 points, and 42 points \div 3 points/basket is 14 baskets.
2. **(9 and 36)** Students can think of each larger block on the right-hand scale as composed of 4 small blocks. Therefore the right-hand scale shows that $4 + 4 + 3$ or 11 small blocks weigh 99 grams. Or, each small block weighs 9 grams. Then a large block is 4×9 grams, or 36 grams.
3. **(6/36 or 1/6 or 17%)** There are 6 ways to have a sum of 7 on a pair of dice: (1,6), (6,1), (2,5), (5,2), (3,4) and (4,3). There are 36 possible ways that two dice can land "up." Therefore the chance of getting a sum of 7 is $6/36$ or $1/6$.
4. **(1/3)** There are a number of ways for students to get this answer. One way is to add the large $1/4$ of a square to the smaller pieces, which are $3/36$ of the square, getting $9/36 + 3/36 = 12/36$ or $1/3$.
5. **(Shapes A, C, and D should be circled.)** Students with good visualization skills can do this problem without any physical representations. For other students, they might want to trace the figures, cut them out, and try to fold them along the lines given.
6. **(6)** 85% of 40 is 34, so Alfonso must correctly answer at least 34 questions. This means he can miss up to 6 questions.
7. **(5 \rightarrow 26; 6 \rightarrow 37; 7 \rightarrow 50)** The input number is squared and 1 is added.
8. **(a. 10; b. $n^2 + 1$, or $n \times n + 1$)** The problem encourages students to turn around their thinking from the previous problem. If a number that is squared and then increased by 1 gives 101, subtracting 1 from 101 gives the square of the number, 100. Therefore 10 must be the input number. Part (b) involves writing the function using a variable, if it can be generalized.
9. **(Maria, Michael, Gale, Dot, Beth)** Students might want to simply make a vertical list of the students' names, according to the clues given. Gale would go above Beth but below Michael from the first clue. Maria also goes above Michael, from the second clue. Dot goes above Beth but below Gale. Therefore the order is:

Maria
Michael
Gale
Dot
Beth

Commentary

Uranus, VIII

1. (16/20) Students might start listing fractions equivalent to $\frac{4}{5}$, as $\frac{4}{5}$, $\frac{8}{10}$, $\frac{12}{15}$, $\frac{16}{20}$, and so on, until they find one in which the denominator is 4 more than the numerator.

2. (5) Students would benefit greatly by drawing a diagram to solve this classic problem. One is shown to the right.

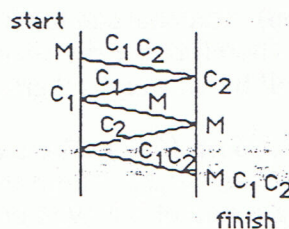

3. (a. 8; b. 18; c. 12) Students will have to imagine the parts of the figure they cannot see. This polyhedra and others like it follow Euler's rule that connects vertices, edges, and faces: $F + V - 2 = E$.

4. (12) Students might start by guessing ages for Anthony since he's the youngest, multiply that by 3 to get Sarah's age, and then add 4 to both ages and see if Sarah will be twice as old as Anthony in 4 years. Doing so yields Anthony as 4 years old, and Sarah as 12.

5. (17) One approach is to notice that giving all 28 animals two legs uses up 56 of the legs. The remaining 22 legs must then be apportioned, in pairs, to make the 4-legged animals. Hence there must be 11 horses. Then $28 - 11 = 17$ is the number of geese.

6. (111 + 11 + 1 or 11 x 11 + 1 + 1) There may be other solutions.

7. (6 and 5) The problem can be approached in a concrete manner that will later be replicated when students begin to solve systems of equations. Notice that doubling what is on both sides of the right-hand scale will give that 4 elephants and 2 donkeys weigh 34 grams. Compared with the left-hand scale which has the same number of donkeys and one less elephant balancing 28 grams, we know that one elephant accounts for the difference between 34 and 28, or one elephant is 6 grams. Then we can use this amount to substitute for the elephant's weight in any of the given scales, and determine that the donkey weighs 5 grams.

8. (204) There are 64 small squares, 49 two-by-two squares, 36 three-by-three squares, 25 four-by-four squares, 16 five-by-five squares, 9 six-by-six squares, 4 seven-by-seven squares, and 1 eight-by-eight square. This totals 204 squares.

9. (b gives \$335169.31 more) This problem is exhausting to do with paper and pencil, but is quite easy with a calculator that has a repeating multiplier concept and a memory key. For such a calculator, pushing either 2×0.01 or 0.01×2 , followed by a sequence of [=] 's, gives the amount he made each of the 25 days. If you also use the [M+] key to add each new day's pay to what he made previously, at the end of 25 days (or 24 [=] 's being pushed), you should have 335544.31 when you push [MR]. You can then subtract $\$15 \times 25$, what he would make at \$15 per day for 25 days, to get the answer above.

Commentary

Uranus, IX

1. **(21, 34)** This pattern is the famous Fibonacci sequence, in which you start with 1, 1, and from there on, each term is the sum of the two preceding terms.
2. **(129)** Students will likely multiply 17×9 and get 153, and then subtract the area of the two holes from that. The rectangle has area 4×4 or 16, and the triangle is half of that, or 8. Therefore 24 must be subtracted from 153, leaving 129.
3. **(28)** The square root of 49 is 7, and $7 \times 10 = 70$. Subtracting 50 leaves 20, and 20×7 is 140. One-fifth of 140 is 28.
4. **(yes)** Most students will take several numbers and try them out, and since they all work, will conclude the number trick works. If one takes a 1-digit number x , and doubles it to get $2x$, adds 5 to get $2x + 5$, multiplies by 5 to get $10x + 25$, subtracts 25 to get $10x$, then one has the single digit again, but this time in the tens place. Removing the last digit, which is always a zero, gives the original number.
5. **(15)** One mile in four minutes means that every four minutes, he could run a mile at that pace. Since there are 15 groups of four minutes each in 60 minutes or an hour, he could run 15 miles in an hour at that pace. He was therefore running 15 miles per hour.
6. **(104,000)** Using a calculator, multiply $72 \times 60 \times 24$ to get 103,680. Rounded to the nearest thousand, this number is 104,000.
7. **(4)** Four pairs of roller blades for every three skateboards is the ratio 4:3. This is the same ratio as 8:6, 12:9, 16:12, and so on. The ratio 16:12 is the one we're after, as that means 16 roller blades were sold. Then 12 skateboards were sold, and $16 - 12 = 4$.
8. **(93)** Students can think of the problem in this way: $(86 + 92 + 88 + 96 + x) \div 5 = 91$. This means that $(86 + 92 + 88 + 96 + x) = 91 \times 5$ or 455. This also means that $x = 455 - (86 + 92 + 88 + 96)$, or $x = 93$. Other students might know that since the average is 91, and the differences between the given scores and 91 are, respectively, -5, +1, -3, and +5, which sums to -2, the remaining test must compensate by scoring +2 over the average, and $91 + 2$ is 93.
9. **(a. \$9600; b. \$6912)** On a calculator, students can multiply \$120,000 by 8% or by 0.08. They can then multiply the result by 72%, which is the percent she would have left, after 28% in taxes is removed.

Commentary

Uranus, X

1. **(15)** Multiply 37 by 3 and you get 111, and by 6 and you get 222. The pattern seems to be that multiplying 37 by 3×1 gives all ones, and by 3×2 gives all twos. So you might guess that multiplying 37 by 3×5 would give all fives. Checking it on a calculator proves this is true.

2. **(a. 35¢; b. 13 pounds; c. 20; d. 10)** Each of these problems is set up in the form of what will later be a linear equation to solve. For (a), you can solve $12x + \$0.28 = \4.48 . For (b) you can solve $5x + 25 = 90$. For (c), $1/2 x + 5 = 15$. For (d), $12x + 6.5 = 126.5$. At this point, students will not use equations to solve the problems -- they will simply subtract first, and then divide.

3.

16	2	3	13
5	11	10	8
9	7	6	12
4	14	15	1

 The key to solving this problem easily is to start in a column in which you already know three of the four numbers necessary to total 34. You can put 6 under the 10, and then you know the number to the left of 6 must be 7. You also know that 16 must be in the upper left corner. From that point, *guess-check-revise* will enable students to solve the problem.

4. **(40)** Use a proportion to solve. $\frac{16}{27} = \frac{x}{67.5} \quad x = 40$

5. **(10)** Students will be helped by placing letters of the alphabet at the corners, and describing each path using these letters. Using the letters placed as below, the ten trips are completely determined by this list:

ABCE; ADCE; ADFE; ADFJ; GDCE; GDFE; GDFJ; GHFE; GHFJ; GHIJ

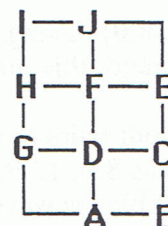

6. **(7, 9)** The function machine takes the square root of the number dropped in.

7. **(2:27 P.M.)** *Guess, check, and revise* may be the way students approach the problem. For example, guess 2:30 as the time -- in 16 more minutes, it is 2:46, which is 14 minutes before 3:00. But 10 minutes before 2:30 would be 2:20, which is 20 minutes after 2:00. So 2:30 doesn't work -- revise the guess down a little, and check as above. Eventually, 2:27 works as 16 minutes later it is 2:43, which is 17 minutes before 3:00; and 10 minutes before 2:27 was 2:17, which is 17 minutes after 2:00.

8. **(25%)** Students could fill in the grid to see that there are 2 shaded squares of the 8 small squares.

$$\frac{2}{8} = \frac{1}{4} = 25\%$$

Commentary

Uranus, XI

1. **(a. \$7.18; b. \$6.28)** For (a), students can multiply \$2.99 times 2.4; for part (b), they can multiply \$2.99 times 2.1. In each case, they would round their answer up to the next cent.
2. **(notebook costs \$1.25; pencil costs \$0.25)** Students can solve this by *guess-check-revise*. They can guess the cost of the notebook first, determine the cost of the pencil as the difference between what is chosen for the notebook and \$1.50, and see if the difference in the two items is \$1. If not, revise the guess.
3. **(37 yd² or 37 sq. yd.)** Divide the shape into two rectangles and find the area of each. One rectangle is 3 by 3 or 9 square yards. The second is 4 by 7 or 28 square yards. $28 + 9 = 37$ square yards. The shape could also be divided into rectangles that are 3 by 7 and 4 by 4. For full credit, students must have the correct label.
4. **($\frac{1}{2}$, $\frac{7}{12}$, $\frac{2}{3}$, $\frac{3}{4}$, $\frac{5}{6}$)** Changing all of the fractions so they have the denominator 12 allows one to order them by looking at the numerators.
5. **(15%)** The increase is \$0.60. $\$0.60 \div \$4 = 0.15 = 15\%$. Another way to see this result is to take $60/400$, reduce it to lowest terms, $3/20$, and rename this fraction as $15/100$, which is 15%.
6. **(a. 529 or 23²; b. 1000 or 10³)** Square the row number to get the middle entry. The sum of the numbers in the row is the cube of the number of the row. $10^3 = 1000$
7. **(ten thousands)**
- 8.

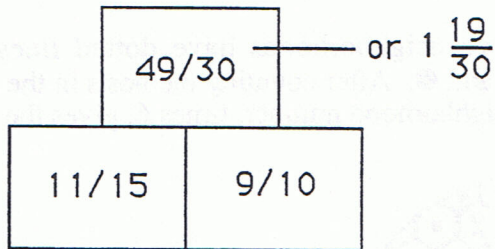

9. **(a. 3 cups; b. 1/2 cup)** Part (a) involves simple realizing that $3/4$ of 4 is 3. Part (b) involves finding $3/4$ of $2/3$. This can be done by drawing a figure, or mathematically by finding $3/4 \times 2/3$ or $2/4$ or $1/2$.

Commentary

Uranus, XII

1. (a. $26=23+3$ or $26=7+19$; b. $82=23+59$ or $82=11+71$ or $82=29+53$ or $82=3+79$)
2. (9) Three diagonals can be drawn from each of the vertices of a hexagon. There are 6 vertices. $6 \times 3 = 18$. However, the diagonals will have been counted twice, once at each vertex. So the total is half of 18.
3. (2,6,-3) Students will probably have to take the factors of 36, and try them in groups of three, until they find a group in which the product is -36 and the sum is 5. They will be helped by remembering that a negative product and positive sum means that one number is negative.
 $2 \times 6 \times -3 = -36$ and $2 + 6 + -3 = 5$
4. (44) $2^4 = 16$; $3^3 = 27$; $4^0 = 1$; The sum is 44.
5. (1/4 or 25% or 0.25) It doesn't matter what the first spin is. The chance that the second spin will match it is 1/4.
6. (2.5) Many students will select one of the other choices because of the number of digits they have.
7. (21,300) $10,000 + 10,000 + 1,000 + 100 + 100 + 100 = 21,300$
8. (2 dimes, 8 nickels, 40 pennies) Students will likely guess-check-revise to solve this problem. A good place to start is with the number of pennies, which has to be most of the 50 coins due to the size of the other coins. There can't be 50 pennies, so try 45. That turns out to be impossible, so drop back to 40. There is a possibility with 40 pennies.
9. (a. 6; b. 12; c. 18, 24, 30; d. $6n$) The first two neighborhoods have dotted lines through them. The next three are marked by \checkmark , \times , and \bullet . After counting the nests in the first five neighborhoods, students will notice that the neighborhood number, times 6, gives the number of nests.

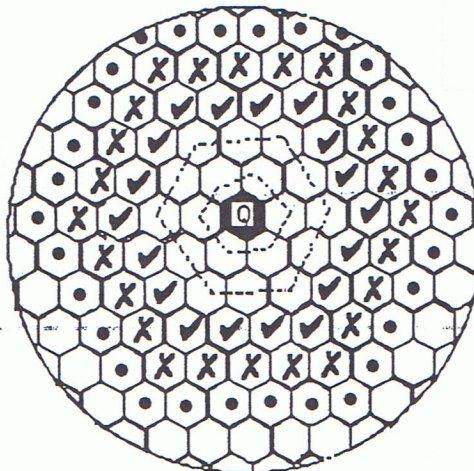

Commentary

Uranus, XIII

1. (a. see below; b. 55; c. 385) Each building in the pattern adds on the square of the "building number" of cubes. The 5th building would add 25 more cubes, the 6th would add 36, and so on. The cubes needed for Building 10 would therefore be $10^2 + 9^2 + \dots + 1^2 = 385$.

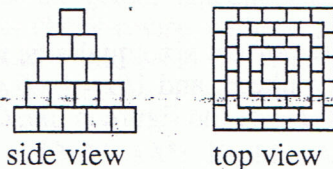

2. (94) An average of 90 on 4 tests means the sum of the four was $4(90)$ or 360. Subtracting the three known tests from 360 leaves 94, the score for the fourth test.
3. (a. 19.99; b. 0) For (a), think of $9 \frac{3}{5}$ as 9.6 and compute on a calculator. For (b), change all of the fractions to denominator 24, and the numerators will sum to zero.
4. (39 days) Students are tempted to take half of 40 days, and report 20 days. However, if the pond was half-covered on day 20, on day 21 it would be completely covered because the water lilies double in size each day.
5. (HELP! is spelled out backwards.)

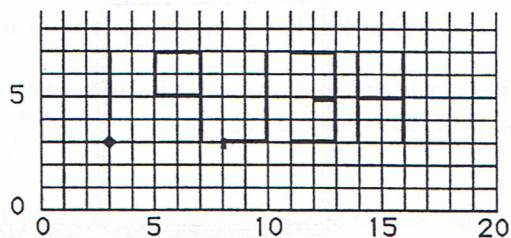

6. (675) The trip from Pensacola to Jacksonville is 7 cm or 7×50 miles, or 350, miles. The trip from Jacksonville to Miami is 6.5 cm, or 6.5×50 miles, which is 325 miles. The sum of the two is 675 miles.
7. (6,210,001,000) The way students will solve this problem is to guess-check-revise, likely starting at the left end with the guess 9,000,000,000. But this isn't quite right because it doesn't indicate there's 1 nine. So you alter the number to 8,000,000,001. But this has no 9 now, but it does have an 8, so you adjust again to 8,000,000,010. But, now there's a 1 in the number, which isn't accounted for. You continue to adjust the number in this fashion, working on both the right and left-hand ends, toward the middle. After much erasing, you get the answer above. Students will do much better if they make 10 blanks in ink, and write in numbers they can erase in pencil. It also helps to place below each blank what the digit represents, as below:

Commentary

Uranus, XIV

1. (a. 2nd b. 5th c. 1st d. 4th e. 3rd) Students can draw a picture to help them think through this problem.
2. (210) $750 \div 25 = 30$, meaning that Bobo weighs 30 times as much as 25 pounds, and so needs 30 times 7 mL of vitamin.
3. (A = 50%; B = 17%; C = 33%) Three of the six equal-size regions are shaded like A, giving half or 50%. One region is shaded like B, and $1/6 = 1 \div 6 = 0.17$ when rounded, or 17%. Two out of six are shaded as C, so $1/3$ of the figure is like C -- this is $33\frac{1}{3}\%$, but this is 33% when rounded.
4. (2) A Venn diagram helps students see the situation. It's usually helpful to work from the overlap area toward the outside.

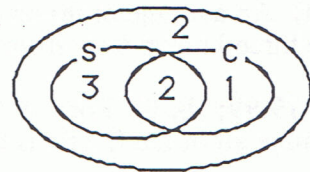

5. (See below.) Move three of the pencils on either of two ends.

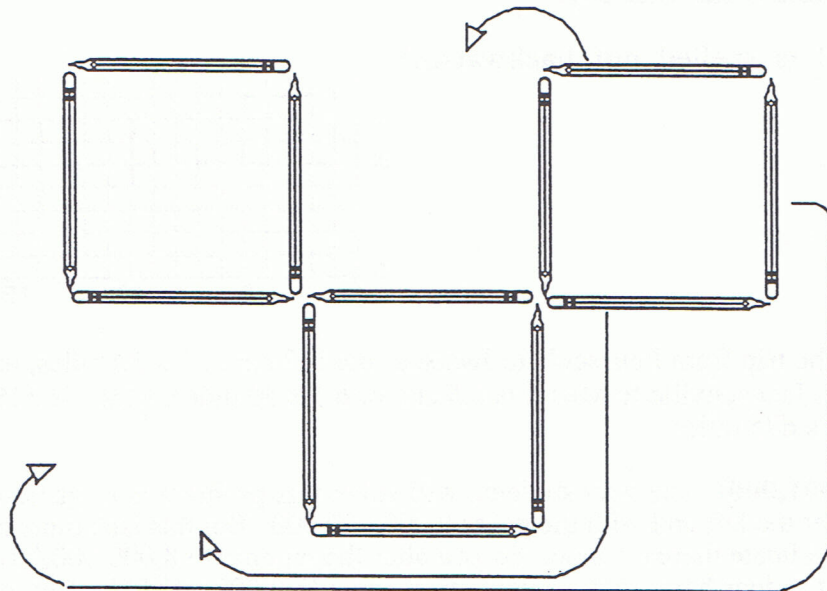

6. (20) If the helium balloons are removed from the scale, it will read 15 grams more than it does at present. Therefore the two cans by themselves would have a reading of $25 + 15$ or 40 grams. Then each can would weigh half of that, or 20 grams. An equation for this situation is $2x + 15 = 25$.
7. (26c) It's possible that the first 12 gumballs you get will result in two gumballs of each of the six colors. However, the next time, you must get a gumball that matches two others.

Commentary

Uranus, XVI

1. (233) As you read each clue, mark out those that do not fit the clue. $588 \div 3 = 196$, so mark out 144, 151, 123. Mark out the even numbers 324, 214, 304, 342. Now 233 and 323 remain. In 233 the tens and ones have a sum of 6.
2. (12) Girls and boys are in the class in a ratio of 3:2. So, 2 out of every 5 students in the class are boys. $\frac{2}{5}$ of 30 = 12.
3. (triangular prism). Some students may trace over the figure, and cut it out and fold it up to see the triangular prism.
4. (250) $60 \div \frac{1}{4} = 60 \times \frac{4}{1} = 240$; $240 + 10 = 250$.
5. (24) $4! = 4 \times 3 \times 2 \times 1$. Another approach is to make an organized list. Label the books A, B, C, and D, and list the combinations.

ABCD	BACD	CABD	DABC
ABDC	BADC	CADB	DACB
ACBD	BCAD	CBAD	DBAC
ACDB	BCDA	CBDA	DBCA
ADBC	BDAC	CDAB	DCAB
ADCB	BDCA	CDBA	DCBA

6. (19, 23, 29) This is the set of prime numbers.
7. (Dorothy -- purple, hammers; Jake -- blue, fish; Vicky -- yellow, marbles; Otis -- green, spiders; Nick -- red, watches) Students may wish to make a logic chart to help them organize info. They could take the given chart, and add in letters to represent the colors and collections, as shown below, and proceed by marking out impossibilities indicated by the clues, and circling things they know. Process of elimination usually comes into play in these problems in that once you know a given fact, such as Nick's jacket being red from clue (c), you can cross out red everywhere else.

	Jacket	Collection
Dorothy	r b y p g	s m h f w

8. (T)
S U All letters above the line are made of straight lines. Those below the line have some curved lines.
9. (5)

10 L	4 L	3 L	
10	0	0	start
6	4	0	after filling the 4-liter from the 10-liter
6	1	3	after filling the 3-liter, from the 4-liter
9	1	0	after pouring what's in the 3-liter into the 10-liter
9	0	1	after pouring what's in the 4-liter into the 3-liter
5	4	1	after refilling the 4-liter from the 10-liter

Commentary

Uranus, XVII

1. ($\frac{27}{16}$ or $1\frac{11}{16}$) Students can choose any line and add the four fractions found there.
2. ($\frac{15}{8}$ or $1\frac{7}{8}$) Accept alternate answers from students which are not in lowest terms: $\frac{30}{16}$ or $1\frac{14}{16}$
3. ($\frac{17}{16}$ or $1\frac{1}{16}$) The sum should be the same for each of the six triangles.
4. (**a = 6; b = 9; c = 4; d = 1; e = 3; f = 8; g = 7; h = 2; i = 5; j = 0**) Note that e and f may be switched.
5. **(D)** The probability of getting a black marble in the boxes is:
a) $\frac{1}{4}$ b) $\frac{5}{11}$ (c) $\frac{2}{5}$ d) $\frac{4}{7}$
Box D would be the best choice since $\frac{4}{7}$ is greater than any of the other fractions. Students can decide this by placing them all over a common denominator, or by using a calculator and dividing the numerator by the denominator. Another easy way is to note that $\frac{4}{7}$ is the only fraction greater than $\frac{1}{2}$, and therefore has to be the largest.
6. **(29)** Drawing a picture helps to solve problems such as this. The last cut produces 2 pieces.
7. **(15)** Students can find this volume by counting, but must realize that there are 3 cubes on the "back side" which they don't see. The clue in the problem says that the figure looks the same from the back.
8. **(a. 9; b. 7)** For part (a), to be divisible by three, the sum of the digits must be a multiple of three. For part (b), to be divisible by nine, the sum of the digits must be a multiple of nine. Another easy way to approach both problems, without using the rules of divisibility, is to use a calculator and begin by inserting 9 into the blank space for (a), and see if you get a whole number answer when dividing by 3. If not, move to the next largest digit 8 in the blank. Proceed in this fashion until you have the largest digit that can be substituted, and results in a whole number answer. The same process works for (b), except you divide by 9.
9. ($\frac{1}{2}$, $\frac{1}{3}$, $\frac{1}{6}$) Other answers are possible.
10. **(147)** Adding 132 to 456 gives the total number of points, 588. Divide 588 by four to get the average, 147.

Commentary

Uranus, XVIII

1. (74) $5 + 6 + 7 + 8 + 9 + 10 + 11 + 12 + 1 + 2 + 3 = 74$
2. ($2 \times 3 \times 5$) Students may draw a factor tree to determine the prime factorization. Such a tree is not unique, but gives a unique answer.
3. (14) 10 blocks are in the bottom layer and 4 are in the top layer.
4. (2 inches) Since the model is $1/20$ the size of the truck, the letters should be $1/20$ the size of the original letters. Computing $1/20$ of 40 gives 2.
5. (2 years, 270 days) One ton is 2000 pounds, so eating 2 pounds a day means it takes $2000 \div 2$ or 1000 days. At 365 days a year, 2 years would be 730 days. $1000 - 730$ days = 270 days.
6. () The pattern involves a club and a heart. The club appears in this fashion: 1, 2, 3, 4, ... while the heart appears as 2, 2, 2, 2, ... and separates the clubs. The pattern then becomes one of: $1 + 2 + 2 + 2 + 3 + 2 + 4 + 2 + 5 + 2 + \dots$ until you get to or past 100. With a calculator, you get exactly to 100 when you add 12 above; the 12 indicates you are in the club part of the pattern. Therefore the 100th term is a club.
7. (20,736) $12 \times 12 = 144$; $144 \times 12 = 1728$; $1728 \times 12 = 20,736$ or $12^4 = 20,736$
8. ($a=28.92604$ $b=3.85$) For (a), round off the numbers mentally to 7 and 4 and multiply. For (b), 0.98 is almost 1. Any number divided by 1 is the same number.
9. (55) The helium balloon on the left scale must be "pulling up" with the power of a 15-gram pull, since it and 25 grams balances 10 grams. Therefore we can consider its weight as -15 grams. On the right-hand scale, the two balloons would have a weight of -30; the bag of groceries must then have a weight of 55, so that the groceries and balloons together cancel out 25 grams. These situations are expressed mathematically as:
$$-15 + 25 = 10 \quad \text{and} \quad -15 + -15 + x = 25, \text{ so } x = 55.$$

Note: it's easy for students to see that, when you have a helium balloon that "pulls up" on a scale as -15 grams, the balloons can be replaced on the other side of the scale by a positive weight of that amount. I.e., -15 can be "moved over" to +15, on the other side of the scale.
10. (KX) Line up letters of the alphabet and divide them in half. A starts off the first half and N starts off the second half. B and O are next in the two sets; skip 1 letter to get D and Q; skip 2 letters for G and T; skip 3 letters to get K and X. The terms also alternate from upper case pairs to lower case pairs.

Commentary

Uranus, XIX

1. **(22 yards)** From the 38 to the 50-yard line is 12 yards, and from the 50 to the 40-yard line is another 10, and $10 + 12 = 22$.
2. **(a. bike; b. three times faster)** The $\frac{6}{15}$ of an hour Ryan spends walking is $\frac{6}{15} \times 60$ minutes, or 24 minutes. Riding his bike takes 8 minutes.
3. **(A = 12; B = 2; C = 3; D = 16)** Students can solve for A, B, C, and D by *guess-check-revise*. They would look at factors of 24, 48, 6, and 192 that “work out” in the equations, when used together. The first and second equations together tell you that A and B should be 12 and 2.

4. **(See right.)** Many students will miss this problem because they fail to go outside the “invisible boundary lines” that the brain places on the figure, because of the dots arranged in a square.

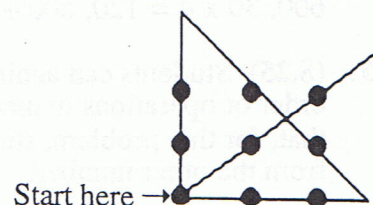

5. **(32)** Six feet is 12×6 inches, or 72 inches. This amount divided by $2\frac{1}{4}$ inches can be done using fractions ($72 \div 2\frac{1}{4} = 72 \div \frac{9}{4} = 72 \times \frac{4}{9} = 8 \times \frac{4}{1} = 32$). It can also be done by converting $2\frac{1}{4}$ inches to 2.25 inches, and dividing as a decimal or using a calculator.
6. **(See right.)** Successful students will probably start at the bottom of the problem, multiplying 19×3 to get 57, and working up to the top of the problem.

$$\begin{array}{r}
 \overline{) \begin{array}{|c|c|c|} \hline 2 & 3 & \\ \hline \end{array} } \\
 \underline{19 \begin{array}{|c|c|c|} \hline 4 & 3 & 7 \\ \hline \end{array} } \\
 \begin{array}{|c|c|} \hline 3 & 8 \\ \hline \end{array} \\
 \underline{ \begin{array}{|c|c|} \hline 5 & 7 \\ \hline \end{array} } \\
 \begin{array}{|c|c|} \hline 5 & 7 \\ \hline \end{array} \\
 \underline{ \phantom{\begin{array}{|c|c|} \hline 5 & 7 \\ \hline \end{array}}} \\
 0
 \end{array}$$

7. **(Black -- 10; Dotted -- 2; Striped: $9\frac{1}{2}$; Crossed: $\frac{1}{2}$)** Students might be more successful if they draw in the grid lines, and count squares and half-squares.
8. **(7 scores)** There are 10 possible ways the arrows could land: (1,1,1); (1,1,3); (1,1,5); (1,3,5); (1,3,3); (1,5,5); (3,3,3); (3,3,5); (3,5,5); and (5,5,5). However, these only produce these seven scores: 3, 5, 7, 9, 11, 13, and 15.

Commentary

Uranus, XX

1. (1537 or 1739) Start by placing a 1 in the thousands place. They can then *guess-check-revise* to find that the other digits are 5, 3, and 7, or 7, 3, and 9 respectively.
2. (11.1 %) Accept 11% also. To solve this problem, students might suppose the original salary was \$100. Then after the decrease of 10%, she's making \$90. To get back to \$100, the salary must increase by \$10 -- the question is -- what percent of \$90 is \$10? $10 \div 90 = 0.111\dots$, which is 11.1%.
3. (a decimal point) A decimal point changes "23" into "2.3" which is between 2 and 3.
4. (700 hours) Students might use a calculator to multiply 29.5×24 . Rounding: $30 \times 20 = 600$, $30 \times 4 = 120$, $600 + 120 = 720$ - closer to 700.
5. (8.25) Students can again use a calculator. "My Dear Aunt Sally" is a way to remember the order of operations in mathematics -- multiply, divide, add, and then subtract. This means that, for this problem, students must compute 4.8×1.7 before subtracting this amount, 8.16, from the other numbers.

6. (See one solution to the right.) Students can guess-check-revise to place the numbers at the corners. They might start by placing 8 and 7 on opposite corners, and 1 and 2 on the same face with 7 and 8, but also on opposite corners. That way they have the two highest balanced off by the two least numbers.

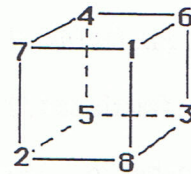

7. (4,992,000) The system would incorrectly answer 13,000 calls per hour per system, or 208,000 calls for all 16 systems per hour. Multiply that times 24 hours, and the number of incorrectly answered calls in a day is 4,992,000.
8. (40 pennies, 8 nickels, 2 dimes or 45 pennies, 2 nickels, 2 dimes, 1 quarter) One key to solving this problem is to realize that most of the coins must be pennies, so start with large numbers of pennies and see if you can make the other coins "fit." 50 pennies won't work, obviously, so drop back to 45 pennies. After some manipulation, you can see that 2 nickels, 2 dimes, and a quarter give 65¢, which when added to 45¢ gives \$1, and it consists of 10 coins. Try 40 pennies, and again you can gain a solution.

9. (The two figures to the far right should be ringed.) A network is *one drawable* if it has 2 *odd vertices* or no *odd vertices*. A vertex is odd if it has an odd number of paths going in or coming out. To trace a network with no odd vertices, start anywhere and you'll finish tracing it back at the same point where you started. If it has 2 odd vertices, you can trace it if you start at one of the odd vertices, and you'll finish up at the other odd vertex.

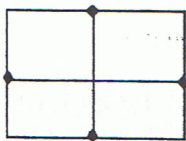

4 odd vertices



6 odd vertices

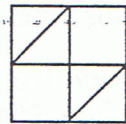

no odd vertices

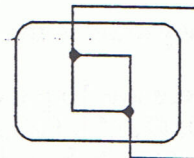

2 odd vertices

Commentary

Uranus, XXI

1. (**\$1.22**) $\$2.15 + \$1.45 = \$3.60$, and $\$3.60 \times 1.05 = \3.78 gives the price plus tax. This amount subtracted from $\$5.00$ is $\$1.22$.
2. (**The decimal point and ¢ sign together means the sign implied the price was 99 hundredths of a penny, which is less than a penny.**) This mistake is a very common one in society. Students might want to begin looking for such mistakes by store owners, and asking them for their change from a penny, for such purposes. They should keep a sense of humor, however, as most store clerks won't know what they're talking about when they try to explain it.
3. (**3 and 5**) Jefferson has 9 letters and Carter has 6 letters, giving 15 in all. The prime factors of 15 are 3 and 5.
4. (**3**) Students might guess-check-revise on the total number of games played in which they win 70%. A good place to start is with 10 games, since it's easy to find 70% of 10. In this case, this guess is correct as they would win 7 games -- 70% of 10 is 7 -- meaning they lost 3 games, and they won 4 more than they lost.
5. (**d**) Students might calculate both areas. The given area is 5×10 or 50 cm^2 ; after the length and width are doubled, the area is 10×20 or 200 cm^2 . 200 is 4 times as much as 50. Many students who don't calculate both areas will immediately think the area is doubled.
6. (**duck and turtle**) Students can reason that, from the second tug-of-war, 1 duck equals 2 turtles in pulling power. So in the first tug-of-war, they can substitute a duck for two turtles and know that a duck and a turtle pulls as hard as 5 fish. Then in the bottom tug-of-war, the duck and turtle could outpull 4 fish.
7. (**8.5**) After 7.5 and 9.0 are thrown out, students can find the average of 8.3, 8.8, and 8.4. Some students will add these three numbers and divide by 5, since there were 5 scores to begin. But this gives an unreasonable answer of 5.1.
8. (**1094**) The pattern she noticed is to triple a given weight, then subtract 1, to get the next month's weight. If you triple 41 and subtract 1, you get 122. Triple that and subtract 1 and you get 365. Triple that and subtract 1, and you get 1094.
9. (**6**) Since the dog alone weighs 27 and the dog with two balloons weigh 13, the two balloons must remove 14 from the dog's weight. This means one balloon would remove half of that, or 7. So three balloons would remove 21, leaving 6. This problem can be thought of as using negative numbers in a real-world situation.

Commentary

Uranus, XXII

1. **(0)** Twice 50 and twice 7 is $100 + 14 = 114$. Twice 57 is $57 + 57 = 114$ also.
2. **(\$126)** a) The area of the large rectangle is 18×10 , or 180 cm^2 . The area of the trapezoid is $\frac{1}{2} \times (6 + 12) \times 6$, or 54 cm^2 . The area of the shaded part is then $180 - 54$, or 126 cm^2 .
3. **(26 and 62)** Students might simply list the 2-digit numbers in which the digits have a sum of 8 and the digits are reversed, and see which of them have a difference of 36. They would try $80 - 08 = 72$; $71 - 17 = 54$; $62 - 26 = 36$; $53 - 35 = 18$; $44 - 44 = 0$.
4. **(48)** Each edge of a 64 cubic inch cube is 4 inches long. A cube has 12 edges. $12 \times 4 = 48$.
5. **(215)** $45 + 55 = 100$ $25 + 75 = 100$ $100 + 100 + 15 = 215$
6. **(a. 17; b. 21; c. 101)** Students can make the first few buildings out of cubes, and they will notice that they have to add four more cubes to get each one in order from the previous building. Parts (b) and (c) almost force them to generalize beyond the "next term" approach, to finding a formula that does not depend on adding four to the previous building.
7. **($4 \times T + 1$ or $4T + 1$ or $T + T + T + T + 1$)** Hopefully students will notice the relationship between the building number and the number of blocks required to make it. Accept any equivalent ways to express this number of blocks, using the variable T .
8. **(39)** In working with Venn diagrams, it is often helpful to work from the inside out. That is, first fill in the number in the overlap area of all the sets, then move to the overlap area of each pair of sets. Finally, determine the number in each set which does not overlap another set.

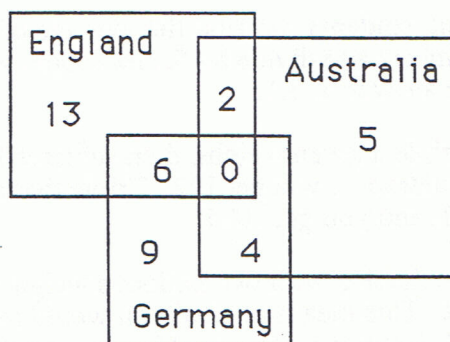

Commentary

Uranus, XXIII

1. **(d. 60 mph)** Pi is 3.14, rounded to two decimal places, and 19π means $19 \times \pi$ or 19×3.14 , which is 59.66 or approximately 60. Or rounding: $3 \times 20 = 60$.
2. **(120°)** The steering wheel has *rotational symmetry*, which means that it can be rotated and will line up with itself. The spokes of the steering wheel partition the circle into 3 congruent parts, so the angles through which it must be rotated to align itself is $360^\circ \div 3 = 120^\circ$.
3. **(21)** Students might be curious as to why this trick works. Let x be the number of brothers or sisters. Doubling x means you have $2x$. Adding 4 gives $2x + 4$. Multiplying by 5 gives $10x + 20$. Adding 1 gives $10x + 21$. Subtracting 10 times the number of brothers and sisters means subtracting $10x$, which gives 21.
4. **(April 12)** It might be helpful to start with how many seconds there are in a 24-hour day, which can be computed as $60 \times 60 \times 24 = 86,400$. Then $1,000,000 \div 86,400 = 11.57$. Therefore in 11.57 days from 1 April, the counting should be over. This would be 12 April, at around 9:41 PM.
5. **(a. 1/12; b. 3/12 or 1/4)** These chances might also be written as percents or decimals.
6. **(One solution is shown below.)** Other arrangements are possible.

4	9	2
8	1	6
3	5	7

7. **(The decimal point should be between "5" and "0" in the answer.)** The only thing incorrect is that the decimal point is in the wrong place in the answer. Some students will say that the person multiplied incorrectly in that the partial products, 405, 2835, and 1215, are wrong. However, this is a legitimate way to multiply, as can be seen by reversing the positions of 4.05 and 3.71, and multiplying using the normal algorithm. This should point out to students that there are a number of ways to multiply, but all should produce a reasonable answer, and an answer close to 1,502 isn't reasonable when you multiply two numbers that are each close to four.
8. **(\$30.50)** Every four spokes would cost \$1.00, so the tires on the bicycle shown have 8 groups of 4 spokes on each tire, which would cost \$8. For two tires, the spokes would run \$16. Add to that \$5.00, \$8.00, and \$1.50 and you'll get \$30.50.

Commentary

Uranus, XXIV

1. (a. 42; b. 2,864 miles; c. 28 mph) Students are often quite interested in such strange records as those found in the *Guinness Book of World Records*. For (a), $1018 \div 24 = 42.4$, which is 42 when rounded to the nearest whole number. For (b), the other two wheels also travelled 2864 miles, as passengers. If students answer "0", give them credit also, as they are interpreting "travel" to mean something different for a tire than a passenger. For (c), $501 \div 17.6 = 28.46$ which is 28 mph, when rounded. Some students will incorrectly round 28.46 to 28.5 first, and then 28.5 up to 29 mph.
2. (27) If two candles stand for 6 years, then each candle is 3 years. 9 candles times 3 is 27 years.
3. (The first two digits tell me how old they are, and the last two tell me how much change they have.) The above description works, except that if the person is a single-digit age, then it's the first digit, not the first two, that give the age. This problem also requires that the change be less than \$1.00.
4. (8) $13.5 - 2.08 = 11.42$. Adding 8.58, written as a decimal rather than a mixed number, gives 20. $40\% \times 20 = 8$.
5. (5) First, students will need to figure out that the problem is written with a reversed image, which can be reversed again by holding it up in front of a mirror. They might be interested in knowing that Leonardo de Vinci wrote many of his manuscripts in this fashion, to protect them from prying eyes. Students might be fooled into thinking that they add or multiply the two fives in the problem. It is easy to see, however, that if they think of the boys and girls lined up in two concentric circles, it only takes 5 turns of one of the wheels, while the other stays stationery, to match each boy with each girl.

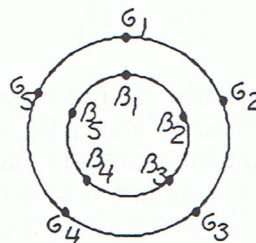

6. (1.5) From the right-hand scale, we know that a strawberry weighs 2 grams. Then on the left-most scale, 3 strawberries or 6 grams balancing 6 cans means each can is 1 gram. In the middle scale, 3 cans weighing 3 grams balance 2 pencils, so each pencil must be half of 3 grams, or 1.5 grams.
7. (clockwise) Gears that are connected in this fashion alternate in direction. If the first goes clockwise, as it turns, it forces the next to go counterclockwise, which forces the next to go clockwise, and so forth. Every odd number of gears will go in the same direction as wheel number 1; every even numbered wheel will go the opposite way.

Commentary

Uranus, XXV

1. **(a. 21,000; b. 7,655,000)** The problem involves multiplication. For (a), $25 \times 60 \times 14 = 21,000$; for (b) $21,000 \times 365 = 7,655,000$.
2. **(180)** Ten pins in each of 15 lanes is 150 pins. Multiplying 150 by 1.2 gives the extra 20% in one step, and $150 \times 1.2 = 180$. There are many other ways students will find the extra 20% -- one common way is to realize that 10% of 150 is 15 pins, so 20% would be twice that or 30 extra pins.
3. **(One solution is shown to the right.)** Students who start with 14 in the middle square, because it's in the middle of the numbers from one through 18, will have an advantage. From that point, they can work in toward the center of the line of numbers, making pairs that have the same sum.

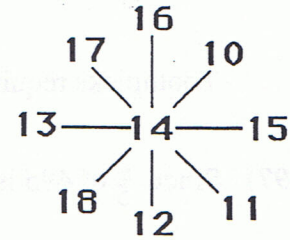

4. **(28)** $1 + 2 + 4 + 7 + 14 = 28$.
5. **(\$7)** If she went in with \$27 and came out with \$6, she spent \$21. Therefore each tape cost, on the average, $\$21 \div 3 = \7 .
6. **($+2\frac{1}{8}$)** The sum of the positive and negative amounts can be combined to find out what the stock was at on Thursday. This can then be compared with its closing price on Friday to find how much it gained or lost on Thursday.

$$\begin{aligned}
 &12\frac{1}{2} + \frac{3}{4} + 1\frac{3}{4} - 5\frac{1}{2} + 2\frac{5}{8} \text{ would give the closing price on Thursday.} \\
 &= 12\frac{4}{8} + \frac{6}{8} + 1\frac{3}{4} - 5\frac{4}{8} + 2\frac{5}{8} = 15\frac{21}{8} - 5\frac{4}{8} = 17\frac{5}{8} - 5\frac{4}{8} = 12\frac{1}{8}
 \end{aligned}$$

This closing price of $12\frac{1}{8}$ is then compared with $14\frac{1}{4} = 14\frac{2}{8}$, and you realize that the stock gained $2\frac{1}{8}$ on Friday.

7. **(10)** There are four 1's in the corners, four more 1's that are part of the 12's that are close to the four corners, and two "ones" printed on the bill.
8. **(Far-left figure should be circled.)** Students might trace the figure using a dark pencil or pen on a sheet of paper or an overhead transparency, and go through the motions described.

Commentary

Uranus, XXVI

1. **(160)** $400 \div 5 = 80$ cars made. If 2 headlights are needed for each car, then 160 headlights are needed.
2. **(a. 45; b. 63; c. 165)** Most students will draw the next few figures and count the toothpicks. They will likely extend figure 4 down several times, to get each new figure, and just count the new toothpicks added on. A pattern emerges which some students might notice, although they might not be able to express it clearly:

	Figure number:					
	1	2	3	4	5 n
Toothpicks required:	3	9	18	30	45 $\frac{(3)(n)(n+1)}{2}$

3. **(297)** Since $\frac{2}{5}$ of 495 is 198, Ashley has already read 198 pages, leaving 297 pages.
4. **(17)** A 20-foot roll of tape is 240" long. A 1 ft. 2 in. section of tape is 14" long. $240" \div 14" = 17.14$. There is not enough tape for the 18th picture.
5. **(1st: Weigh three pieces of gum against another three pieces. If the scale balances, you know the light piece is one of the three in your hand. If the scale doesn't balance, you know which group of 3 pieces has the lighter one. 2nd: Weigh two of the three pieces from the lighter group. If the scale balances, the light piece is in your hand. If it doesn't balance, you know which piece is lighter.)**
6. **(0)** The boat also rises as the tide comes in!
7. **(\$101)** The speed limit was exceeded by 12 mph. $\$80 + 12(\$1.75) = \$101$
8. **(16)** The students need to remember not to count the corner posts more than once. A drawing will help them see the situation.
9. **(540)** There are $27 \times 36 = 972$ square feet in the classroom. Since 9 square feet is 1 square yard, $972 \text{ square feet} \div 9$ gives 108 square yards. $108 \times 5 \text{ people} = 540 \text{ people}$.

Commentary

Uranus, XXVII

1. (See below.) If the scale balances, the clay weighs 25 grams.

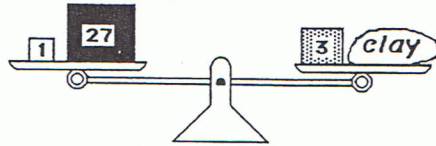

2. (**median**) The mean is $(76 + 76 + 83 + 85 + 90) \div 5 = 82$. The median is the middle number when all are lined up in order, and is 83. The mode is the most frequently occurring number, which is 76. The range is the difference in the highest and lowest scores, which is 14.
3. (See chart to the right.) This is only one solution. Others are possible:

P	N	D	Q
Q	D	N	P
N	P	Q	D
D	Q	P	N

4. (**2 quart jars**) There are 2 pints in a quart; therefore $7 \text{ quarts} + 6 \text{ pints} = 7 \text{ quarts} + 3 \text{ quarts} = 10 \text{ quarts}$; therefore $12 \text{ quarts} - 10 \text{ quarts} = 2 \text{ quarts}$; the fewest jars would be 2 quart jars.
5. (**7/12**) The months with more than 30 days are January, March, May, July, August, October, and December. This is 7 months out of 12.
6. (**\$3,058**) The area to be covered can be found by taking the area of the large rectangle and removing the pool area. The area of the 20-by-30 rectangle is 600 square feet; the area of the 23-by-14 pool is 322 square ft. The difference is $600 - 322 = 278$ square feet. Each square foot would take 4 of the tiles, therefore $4 \times 278 = 1112$ tiles needed. $1112 \text{ tiles} \times \$2.75 = \$3,058$.
7. (**\$10**) The racquet was about \$30, the tennis balls about \$5, the shirt about \$15. He therefore spent about \$50, without counting tax. He should have \$10 left from his \$60 then, if his mom pays the tax for him.
8. (**12**) The 3 classical CDs must have been 25% of the total also, as that's all that is left from 100% when 50% and 25% are removed. If 25% or $1/4 = 3$, then 100% is 4 times 3 or 12.
9. (**69 BC**) The numbers that represent BC years can be thought of as negative number on the number line. The problem becomes finding the number that comes 39 units prior to -30, which would be $-69 - 69 \text{ BC}$. As a check mathematically, notice that $-69 + +39 = -30$.